

You will need:-

- 2 no. Pieces of A4 or A5 sized paper or card
- A Pencil
- A Metal Tape-Measure
- A Ruler

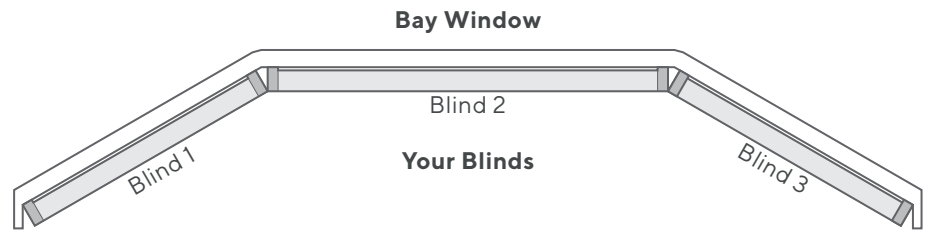

Measure how far any obstructions (such as window handles) protrude from the frame. You'll need to add this measurement to your blind depth.

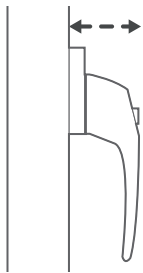

The 'Depth' of your chosen blind is simply the distance which the blind protrudes from where it's fitted. You'll need to know this depth to make the correct allowances when measuring. The table below provides the depths for our pleated blinds:

Blind Type	Depth
Corded Pleated Blind	30mm
Cordless Pleated Blind	45mm

Add these two measurements together and note down the result as 'Measurement A'.

Handle Depth = 27mm

Blind Depth = 30mm

Measurement A = 57mm

- 1** Take your 2 pieces of paper and a ruler. Measure from the back edge of the paper and make a mark at measurement A on both pieces so that the marks are in line.

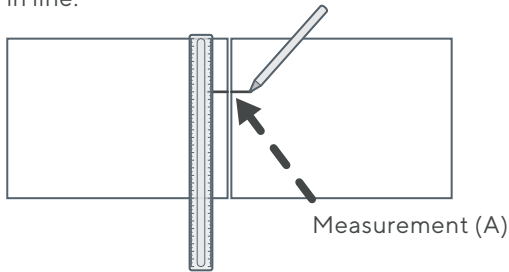

- 2** Place the pieces of paper on the sill, with their back edges touching the window frame. Slide them toward each other until the marks meet.

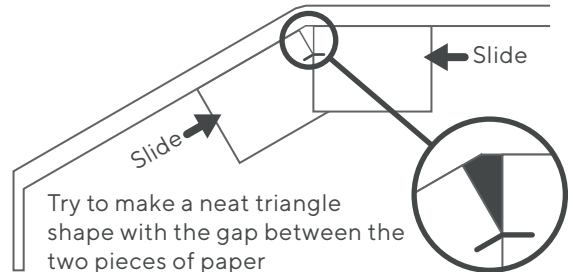

- 3** Follow the edge of the paper back to the frame, and make a mark where each piece of paper meets the frame.

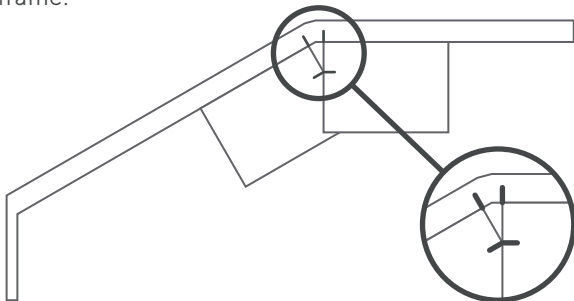

- 4** The width from one mark to the next is the width you'll order each blind. For the left and right blinds, measure from the inside mark over to the wall (mark A in the below diagram). For the centre blind, measure mark to mark (B to B below).

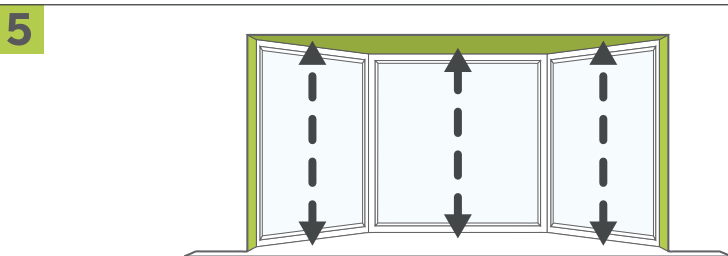
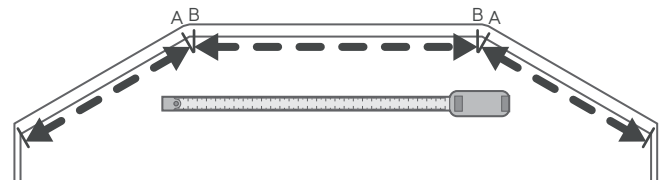

Measuring the drop is simple - simply measure from where the top of the blind is going to sit, down to where you'd like the bottom to rest (usually the sill, if there is one).

All of the blinds for the bay will be ordered as 'exact' fitting.